

Data Sheet



Article number: 204250M1080A1S

Description: E+G levelling foot
GN 42-50-M10-80-A1-S

Note: S Without nut, External hexagon at the bottom

Measures

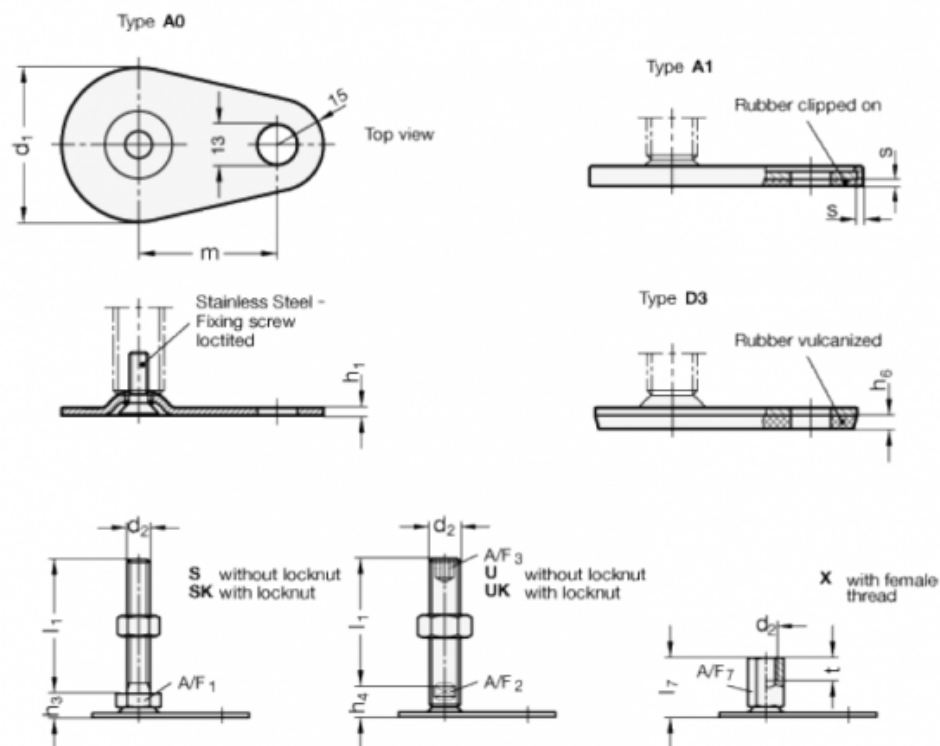

A/F1 = 17	s = 2
d1 = 50	
d2 = M10	
h1 = 2.5	
h3 = 11	
h6 =	
l1 = 80	
m = 45	